

# HiPerFAST™ IGBT IXGH 32N60BU1 with Diode

$V_{CES} = 600 \text{ V}$   
 $I_{C25} = 60 \text{ A}$   
 $V_{CE(sat)} = 2.3 \text{ V}$   
 $t_{fi} = 80 \text{ ns}$

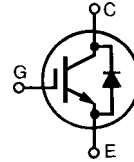

Symbol	Test Conditions	Maximum Ratings	
$V_{CES}$	$T_J = 25^\circ\text{C}$ to $150^\circ\text{C}$	600	V
$V_{CGR}$	$T_J = 25^\circ\text{C}$ to $150^\circ\text{C}$ ; $R_{GE} = 1 \text{ M}\Omega$	600	V
$V_{GES}$	Continuous	$\pm 20$	V
$V_{GEM}$	Transient	$\pm 30$	V
$I_{C25}$	$T_C = 25^\circ\text{C}$	60	A
$I_{C90}$	$T_C = 90^\circ\text{C}$	32	A
$I_{CM}$	$T_C = 25^\circ\text{C}$ , 1 ms	120	A
<b>SSOA (RBSOA)</b>	$V_{GE} = 15 \text{ V}$ , $T_{VJ} = 125^\circ\text{C}$ , $R_G = 33 \Omega$ Clamped inductive load, $L = 100 \mu\text{H}$	$I_{CM} = 64$ @ $0.8 V_{CES}$	A
$P_C$	$T_C = 25^\circ\text{C}$	200	W
$T_J$		-55 ... +150	$^\circ\text{C}$
$T_{JM}$		150	$^\circ\text{C}$
$T_{stg}$		-55 ... +150	$^\circ\text{C}$
Maximum Lead and Tab temperature for soldering 1.6 mm (0.062 in.) from case for 10 s		300	$^\circ\text{C}$
$M_d$	Mounting torque, TO-247 AD	1.13/10	Nm/lb.in.
<b>Weight</b>		6	g

TO-247 AD

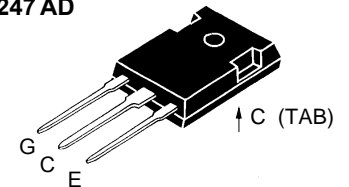

G = Gate,      C = Collector,  
 E = Emitter,    TAB = Collector

## Features

- International standard packages  
JEDEC TO-247 SMD
- High frequency IGBT and antiparallel  
FRED in one package
- High current handling capability
- Newest generation HDMOS™ process
- MOS Gate turn-on  
- drive simplicity

## Applications

- AC motor speed control
- DC servo and robot drives
- DC choppers
- Uninterruptible power supplies (UPS)
- Switched-mode and resonant-mode  
power supplies

## Advantages

- Space savings (two devices in one  
package)
- High power density
- Very fast switching speeds for high  
frequency applications

Symbol	Test Conditions	Characteristic Values ( $T_J = 25^\circ\text{C}$ , unless otherwise specified)		
		min.	typ.	max.
$BV_{CES}$	$I_C = 750 \mu\text{A}$ , $V_{GE} = 0 \text{ V}$	600		V
$V_{GE(th)}$	$I_C = 250 \mu\text{A}$ , $V_{CE} = V_{GE}$	2.5		V
$I_{CES}$	$V_{CE} = 0.8 \cdot V_{CES}$ , $T_J = 25^\circ\text{C}$ $V_{GE} = 0 \text{ V}$ , $T_J = 125^\circ\text{C}$			500 $\mu\text{A}$ 8 mA
$I_{GES}$	$V_{CE} = 0 \text{ V}$ , $V_{GE} = \pm 20 \text{ V}$			$\pm 100 \text{ nA}$
$V_{CE(sat)}$	$I_C = I_{C90}$ , $V_{GE} = 15 \text{ V}$			2.3 V

Symbol	Test Conditions	Characteristic Values ( $T_J = 25^\circ\text{C}$ , unless otherwise specified)		
		min.	typ.	max.
$g_{fs}$	$I_C = I_{C90}$ ; $V_{CE} = 10\text{ V}$ , Pulse test, $t \leq 300\ \mu\text{s}$ , duty cycle $\leq 2\%$	15	25	S
$C_{ies}$	$V_{CE} = 25\text{ V}$ , $V_{GE} = 0\text{ V}$ , $f = 1\text{ MHz}$		2700	pF
$C_{oes}$			270	pF
$C_{res}$			50	pF
$Q_G$	$I_C = I_{C90}$ , $V_{GE} = 15\text{ V}$ , $V_{CE} = 0.5\text{ V}_{CES}$		110	150 nC
$Q_{GE}$			23	35 nC
$Q_{GC}$			40	75 nC
$t_{d(on)}$	<b>Inductive load, <math>T_J = 25^\circ\text{C}</math></b> $I_C = I_{C90}$ , $V_{GE} = 15\text{ V}$ , $L = 100\ \mu\text{H}$ , $V_{CE} = 0.8\text{ V}_{CES}$ , $R_G = R_{off} = 4.7\ \Omega$ Remarks: Switching times may increase for $V_{CE}$ (Clamp) $> 0.8 \cdot V_{CES}$ , higher $T_J$ or increased $R_G$		25	ns
$t_{ri}$			20	ns
$t_{d(off)}$			100	200 ns
$t_{fi}$			80	150 ns
$E_{off}$			0.6	1.2 mJ
$t_{d(on)}$	<b>Inductive load, <math>T_J = 125^\circ\text{C}</math></b> $I_C = I_{C90}$ , $V_{GE} = 15\text{ V}$ , $L = 100\ \mu\text{H}$ , $V_{CE} = 0.8\text{ V}_{CES}$ , $R_G = R_{off} = 4.7\ \Omega$ Remarks: Switching times may increase for $V_{CE}$ (Clamp) $> 0.8 \cdot V_{CES}$ , higher $T_J$ or increased $R_G$		25	ns
$t_{ri}$			25	ns
$E_{on}$			1	mJ
$t_{d(off)}$			120	ns
$t_{fi}$			120	ns
$E_{off}$		1.2	mJ	
$R_{thJC}$				0.62 K/W
$R_{thCK}$			0.25	K/W

### TO-247 AD Outline

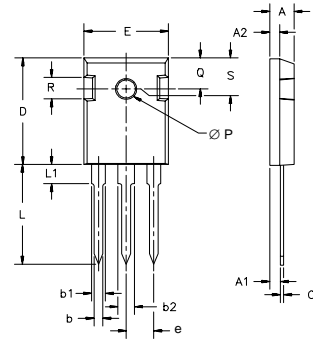

Dim.	Millimeter		Inches	
	Min.	Max.	Min.	Max.
A	4.7	5.3	.185	.209
A <sub>1</sub>	2.2	2.54	.087	.102
A <sub>2</sub>	2.2	2.6	.087	.102
b	1.0	1.4	.040	.055
b <sub>1</sub>	1.65	2.13	.065	.084
b <sub>2</sub>	2.87	3.12	.113	.123
C	.4	.8	.016	.031
D	20.80	21.46	.819	.845
E	15.75	16.26	.610	.640
e	5.20	5.72	0.205	0.225
L	19.81	20.32	.780	.800
L <sub>1</sub>		4.50		.177
ØP	3.55	3.65	.140	.144
Q	5.89	6.40	0.232	0.252
R	4.32	5.49	.170	.216
S	6.15	BSC	.242	BSC

Symbol	Test Conditions	Characteristic Values ( $T_J = 25^\circ\text{C}$ , unless otherwise specified)		
		min.	typ.	max.
$V_F$	$I_F = I_{C90}$ , $V_{GE} = 0\text{ V}$ , Pulse test, $t \leq 300\ \mu\text{s}$ , duty cycle $d \leq 2\%$			1.6 V
$I_{RM}$	$I_F = I_{C90}$ , $V_{GE} = 0\text{ V}$ , $-di_F/dt = 240\text{ A}/\mu\text{s}$ $V_R = 360\text{ V}$ $T_J = 125^\circ\text{C}$ $I_F = 1\text{ A}$ ; $-di/dt = 100\text{ A}/\mu\text{s}$ ; $V_R = 30\text{ V}$ $T_J = 25^\circ\text{C}$		10	15 A
$t_{rr}$			150	ns
			35	50 ns
$R_{thJC}$				1 K/W

IXYS reserves the right to change limits, test conditions, and dimensions.

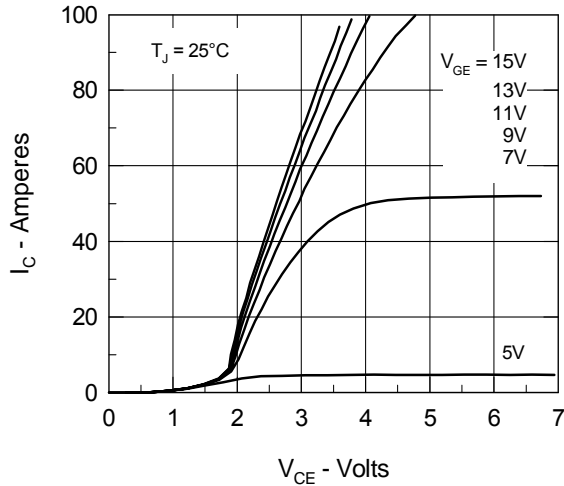

Fig. 1. Saturation Voltage Characteristics

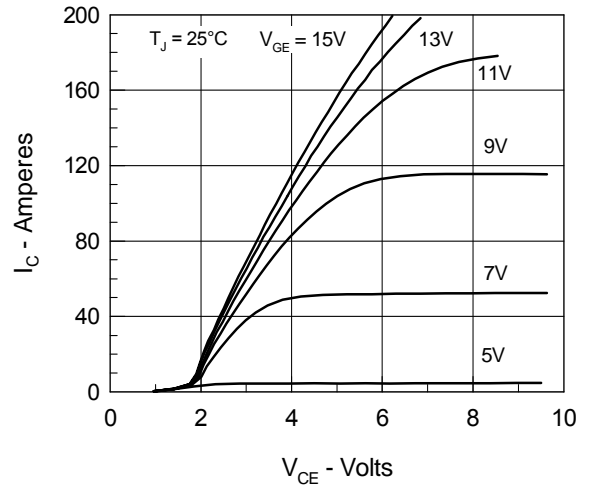

Fig. 2. Extended Output Characteristics

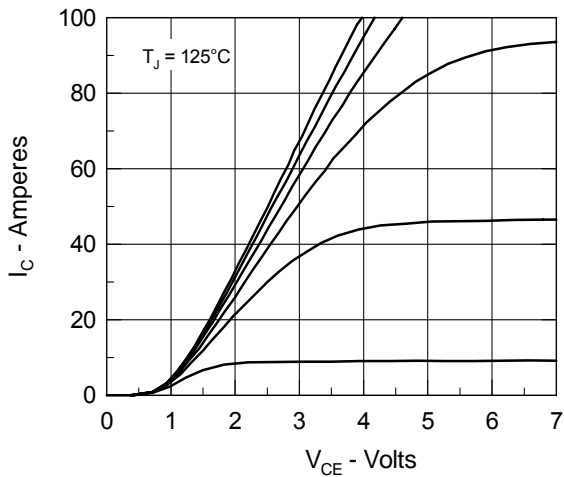

Fig. 3. Saturation Voltage Characteristics

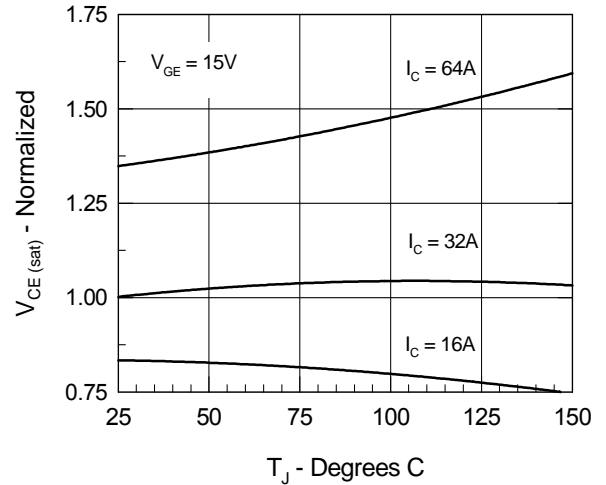
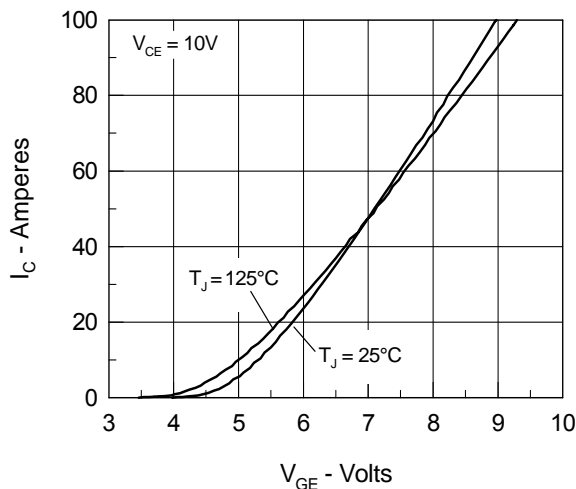
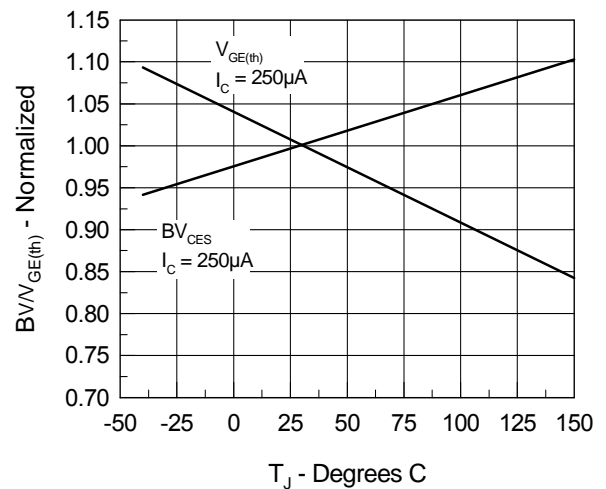

 Fig. 4. Temperature Dependence of  $V_{CE(sat)}$ 

Fig. 5. Admittance Curves

 Fig. 6. Temperature Dependence of  $BV_{DSS}$  &  $V_{GE(th)}$

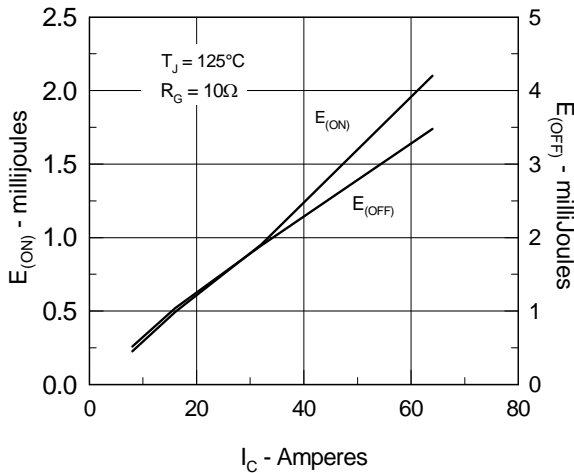

Fig. 7. Dependence of  $t_{fi}$  and  $E_{OFF}$  on  $I_C$ .

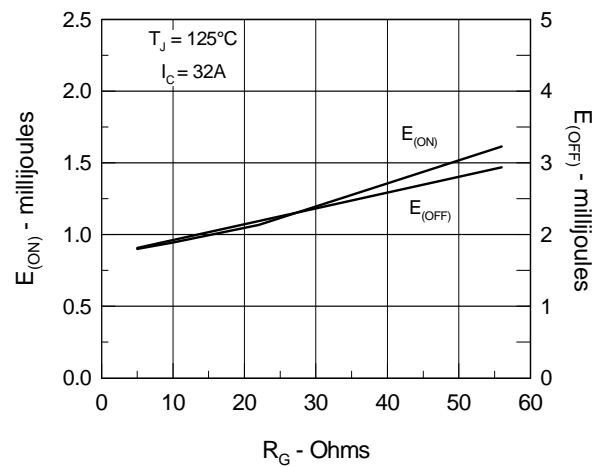

Fig. 8. Dependence of  $t_{fi}$  and  $E_{OFF}$  on  $R_G$ .

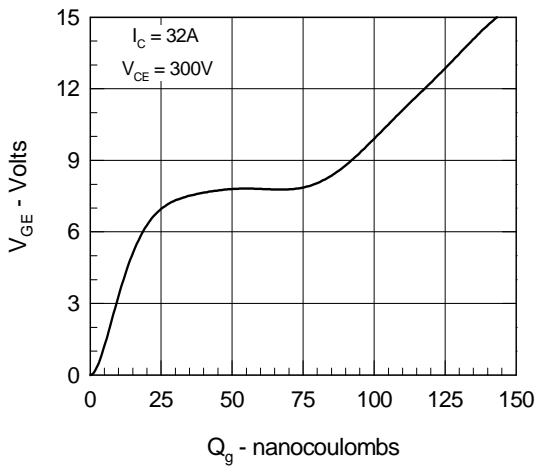

Fig. 9. Gate Charge

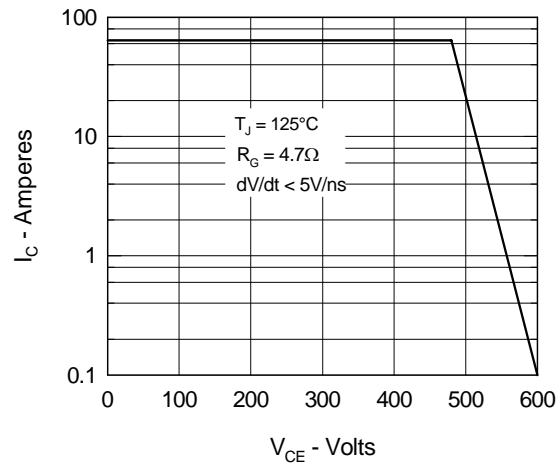

Fig. 10. Turn-off Safe Operating Area

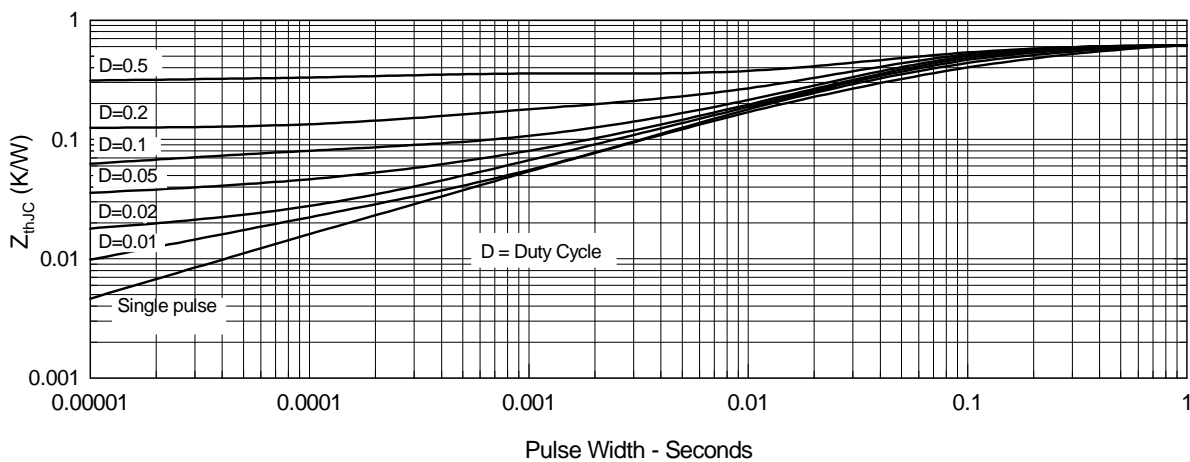

Fig. 11. Transient Thermal Resistance

IXYS reserves the right to change limits, test conditions, and dimensions.

IXYS MOSFETS and IGBTs are covered by one or more of the following U.S. patents:

4,835,592	4,881,106	5,017,508	5,049,961	5,187,117	5,486,715	6,306,728B1
4,850,072	4,931,844	5,034,796	5,063,307	5,237,481	5,381,025	

Fig.12 Maximum Forward Voltage Drop

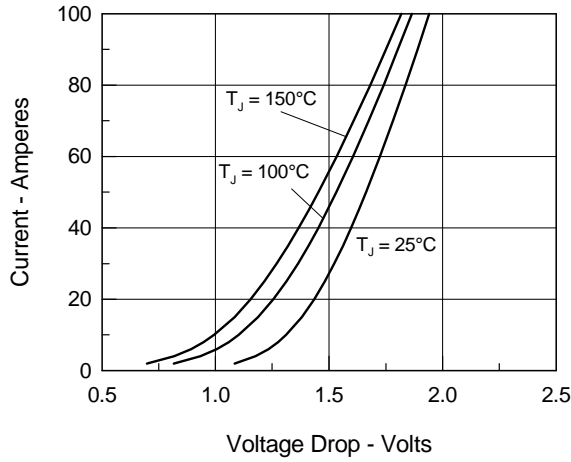

Fig.13 Peak Forward Voltage  $V_{FR}$  and Forward Recovery Time  $t_{FR}$

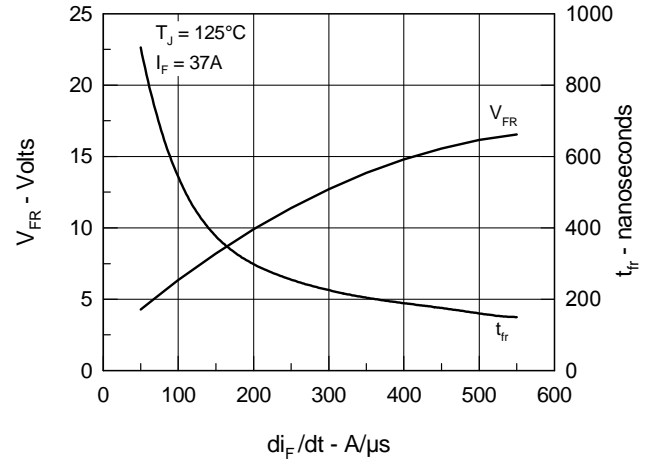

Fig.14 Junction Temperature Dependence off  $I_{RM}$  and  $Q_r$

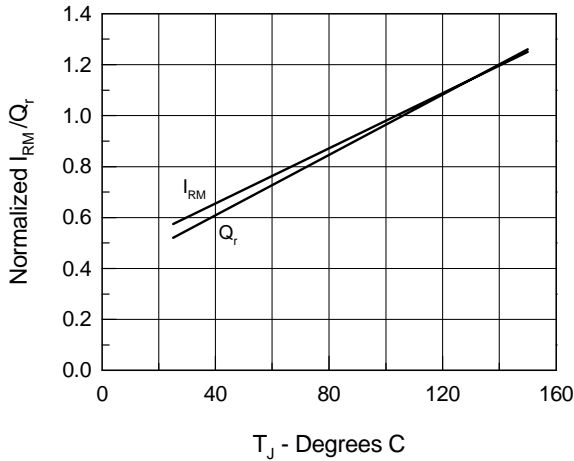

Fig.15 Reverse Recovery Charge

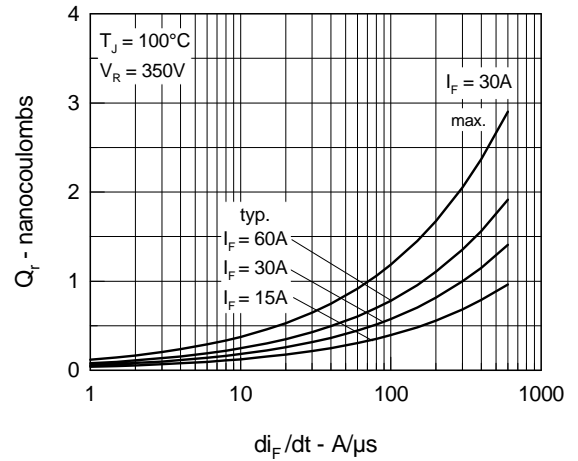

Fig.16 Peak Reverse Recovery Current

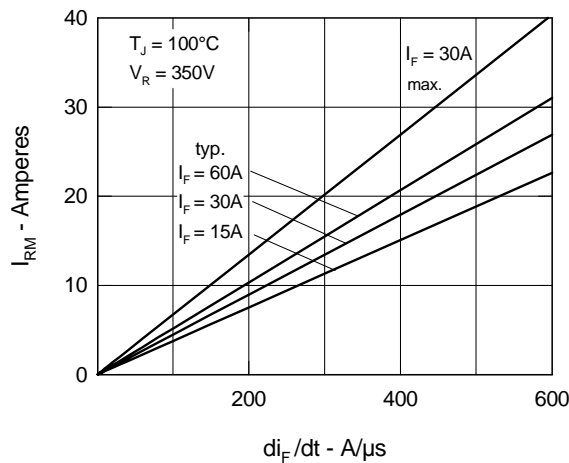

Fig.17 Reverse Recovery Time

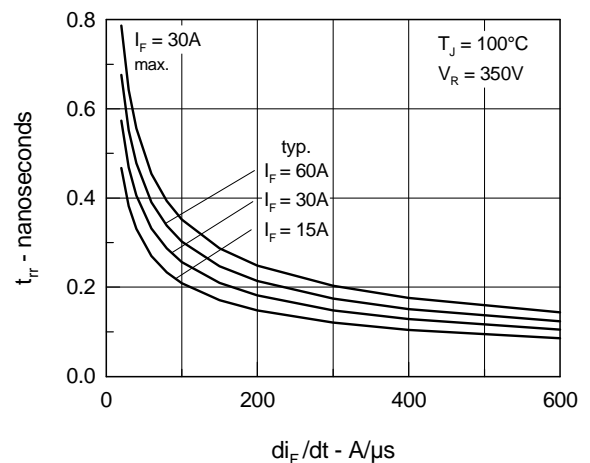
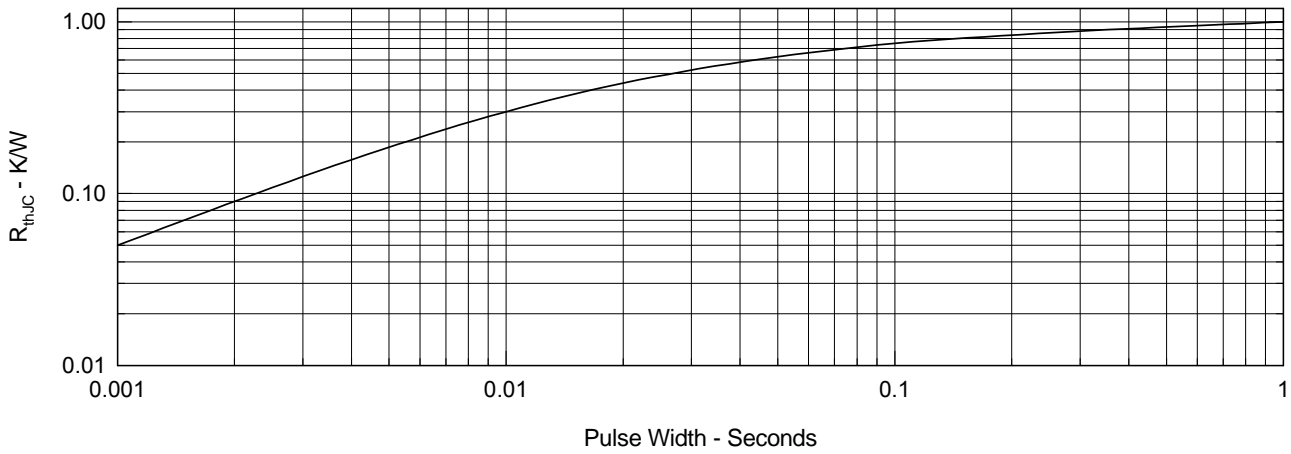

Fig.18 Diode Transient Thermal resistance junction to case



IXYS reserves the right to change limits, test conditions, and dimensions.

IXYS MOSFETS and IGBTs are covered by one or more of the following U.S. patents:

4,835,592	4,881,106	5,017,508	5,049,961	5,187,117	5,486,715	6,306,728B1
4,850,072	4,931,844	5,034,796	5,063,307	5,237,481	5,381,025	